

STANDARD GATE HEIGHTS	
3 FT. - 7 IN.	
5 FT. - 7 IN.	
6 FT. - 7 IN.	
7 FT. - 7 IN.	

UL325 BAFFLE KIT

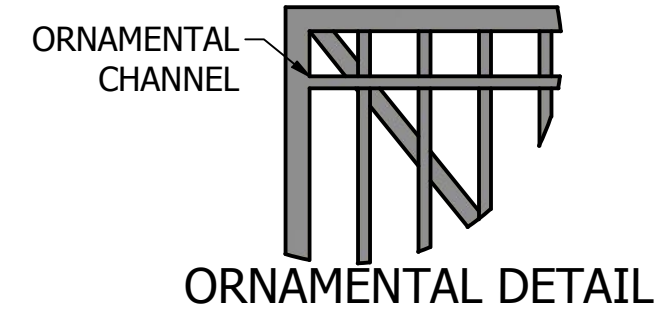

SAFEGLIDE ADJUSTABLE CATCH (QTY. 1)

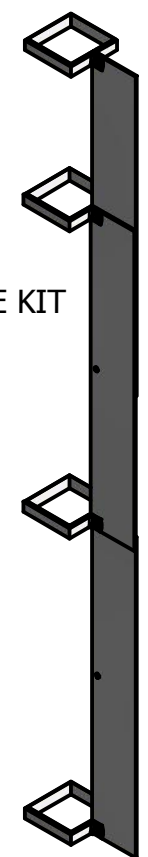
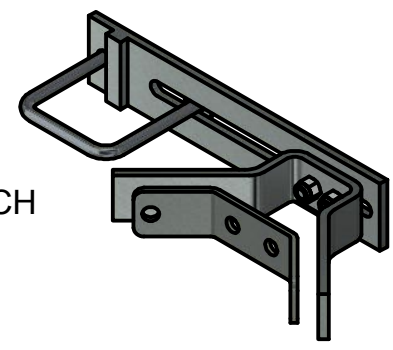

SAFEGLIDE SINGLE WHEEL GUIDE (QTY: 4)

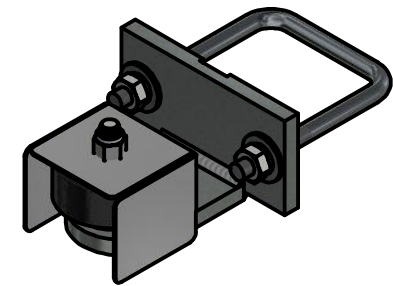

SAFEGLIDE TRUCK ASSEMBLY

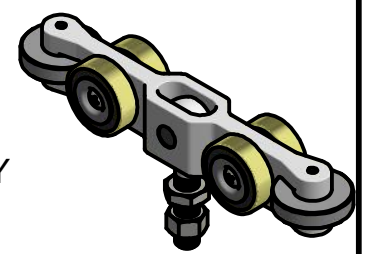

SAFEGLIDE TRACK EXTRUSION AND GATE STOP

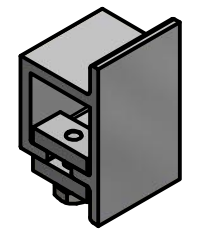

SAFEGLIDE TRUCK HANGER BRACKET (QTY. 4)

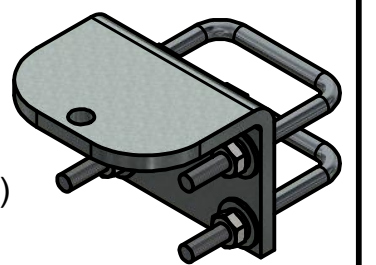

NOTE: GATES 10' HIGH AND UP ARE MANUFACTURED IN TWO PIECES AND REQUIRE FIELD ASSEMBLY. CONTACT PRO ACCESS FOR ADDITIONAL INFORMATION.